

GROUND-FAULT PROTECTION DEVICE 600V MODEL

INSTALLATION AND OPERATION MANUAL



For the most recent manual updates, please visit our website.



www.morningstarcorp.com

TABLE OF CONTENTS

1.0 Important Safety Instructions.....	1
2.0 Dimensions and Features.....	7
3.0 Installation.....	8
3.1.0 Mounting the GFPD-600V Box.....	8
3.1.1 Paired to a Tristar.....	8
3.1.2 Coupling.....	9
3.1.3 Vertical Mounting.....	9
3.1.4 Stand-Alone Use.....	10
3.2.0 Wiring the GFPD-600V Box.....	10
3.2.1 Pre-Wired GFPD-600V / Breaker Assembly.....	10
3.2.2 Completing Wiring.....	10
4.0 GFPD-600V Operation.....	14
4.1 Ground-Fault Detection.....	14
4.2 LED Indications and Audible Warnings.....	15
4.3 Test Button Uses.....	15
5.0 Troubleshooting.....	16
5.1 Faults and Corrections.....	16
6.0 Warranty.....	18
7.0 Technical Specifications.....	19
8.0 Certifications.....	21

1.0 IMPORTANT SAFETY INSTRUCTIONS

SAVE THESE INSTRUCTIONS.

This manual contains important safety instructions for the GFPD-600V. The instructions shall be followed during installation, operation and maintenance of the Ground-Fault Protection Device. The following symbols are used throughout this manual to indicate potentially dangerous conditions or important safety instructions.

CONSERVER CES INSTRUCTIONS.

Ce manuel contient des instructions de sécurité importantes pour le GFPD-600V. Les instructions doivent être suivies pendant l'installation, exploitation et entretien de l'appareil de Protection de fuite à la terre. Les symboles suivants sont utilisés tout au long de ce manuel pour indiquer des conditions potentiellement dangereuses ou des consignes de sécurité importantes.



WARNING: Indicates a potentially dangerous condition.
Use extreme caution when performing this task.



CAUTION: Indicates a critical procedure for safe and proper operation of the GFPD-600V.



NOTE: Indicates a procedure or function that is important for the safe and proper operation of the GFPD-600V.



AVERTISSEMENT: Indique une condition potentiellement dangereuse. Faites preuve d'une prudence extrême lors de la réalisation de cette tâche.



PRUDENCE: Indique une procédure critique pour l'utilisation sûre et correcte du GFPD-600V.



REMARQUE: Indique une procédure ou fonction importante pour l'utilisation sûre et correcte du GFPD-600V.



WARNING: A battery can present a risk of electrical shock or burn from large amounts of short-circuit current, fire, or explosion from vented gases. Observe proper precautions.



CAUTION: When replacing batteries, use properly specified sizes, types, and ratings based on application and system design.



CAUTION: Proper disposal of batteries is required. refer to local regulations or codes for requirements.



AVERTISSEMENT: Une batterie peut présenter un risque de choc électrique ou de brûlure de grandes quantités de court-circuit, incendie ou explosion de ventilé gaz.



PRUDENCE: Observer les précautions adéquates. Quand remplacer l'utilisation de piles correctement spécifié tailles, types, et cotes fondées sur l'application et conception des systèmes.



PRUDENCE: Élimination appropriée des batpiles est nécessaire. Se référer au local règlements ou codes pour exigences.



NOTE: The GFPD-600V must be used with grounded systems, and will interrupt ground-fault current by disconnecting the positive and negative PV conductors, and not the earth ground conductor. Properly grounded batteries will always maintain any earth bond even in ground-fault conditions.



REMARQUE: Le DPDT-600V doit être utilisé avec mise à la terre des systèmes et interrompt la fuite à la terre courant en débranchant le positif et négatif Conducteurs de PV et pas la mise à la terre chef d'orchestre. Les piles correctement mise à la terre sera toujours maintenir une liaison à la terre même en sol fonctionnement anormal.



WARNING: To reduce the risk of electrical shock, do not perform any service other than that specified in the operating instructions, unless you are qualified to do so.

Safety Information

Read all of the instructions and cautions in the manual before beginning installation.

- ◆ There are no user serviceable parts inside the GFPD-600V. Do not disassemble or attempt to repair the device.
- ◆ Disconnect all sources of power to the device before installing or adjusting the GFPD-600V.
- ◆ There are no fuses or disconnects inside the GFS-1 (sensing unit). Do not attempt to repair.
- ◆ Install external circuit disconnects as required.



AVERTISSEMENT: Pour réduire le risque de choc électrique, n'effectuez aucune opération d'entretien autre que celui spécifié dans la notice d'utilisation, sauf si vous êtes qualifié pour cela.

Informations de Sécurité

Lisez toutes les instructions et les avertissements figurant dans le manuel avant de commencer l'installation.

- ◆ Le GFPD-600V ne contient aucune pièce réparable par l'utilisateur. Ne démontez pas ni ne tentez de réparer le appareil.
- ◆ Déconnectez toutes les sources d'alimentation du contrôleur avant d'installer ou de régler le GFPD-600V.
- ◆ Le GFS-1 (unité de détection) ne contient aucun fusible ou interrupteur. Ne tentez pas de réparer.
- ◆ Installation circuit externe se déconnecte au besoin.

Installation Safety Precautions

- ◆ Mount the GFPD-600V indoors. Prevent exposure to the elements and do not allow water to enter the device.
- ◆ Use insulated tools when working with batteries.
- ◆ Avoid wearing jewelry during installation.
- ◆ The battery bank must be comprised of batteries of same type, make, and age.
- ◆ Do not smoke in the vicinity of the battery bank.
- ◆ Power connections must remain tight to avoid excessive heating from a loose connection.
- ◆ Use properly sized conductors.
- ◆ The grounding terminal lug is located in the wiring compartment and is identified by the symbol below:

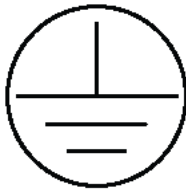

Ground Symbol

- ◆ The GFPD-600V is to be connected in DC circuits only. These DC connections are identified by the symbol below:



Direct Current Symbol

The GFPD-600V must be installed by a qualified technician in accordance with electrical regulations of the country where the product is installed.

Using the GFPD-600V grounding terminal lug (in the wiring compartment), a permanent and reliable conductor to the earth ground must be established.

The grounding conductor must be secured against any accidental detachment.

The knock-outs in GFPD-600V wiring compartment must protect wires with conduit or rings.

Précautions de Sécurité D'installation

- ◆ Mont le GFPD-600V à l'intérieur. Éviter l'exposition aux intempéries et ne permettent pas de l'eau d'entrer dans le périphérique.
- ◆ Utiliser des outils isolés lorsque vous travaillez avec des piles.
- ◆ Éviter de porter des bijoux lors de l'installation.
- ◆ La Banque de batterie doit être composée de piles de même type, marque et l'âge.
- ◆ Ne pas fumer à proximité de la Banque de batterie.
- ◆ Connexions d'alimentation doivent rester serrées pour éviter un échauffement excessif d'une mauvaise connexion.
- ◆ Utilisez la bonne taille des conducteurs.

- ◆ La cosse de mise à la terre se trouve dans le compartiment de câblage et est identifiée par le symbole ci-dessous :

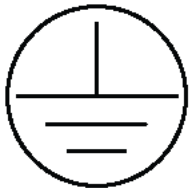

Symbole de la terre

- ◆ Le GFPD-600V doit être raccordé dans les circuits en courant continu. Ces connexions DC sont identifiées par le symbole ci-dessous :



Symbole courant continu

Le GFPD-600V doit être installé par un technicien qualifié conformément à la réglementation électrique du pays où le produit est installé.

À l'aide de la cosse de terre (dans le compartiment de câblage) GFPD-600V, chef d'orchestre permanent et fiable pour la prise de terre doit être établi.

Le conducteur de terre doit être protégée contre tout détachement accidentel.

L'apport défonçables dans compartiment de câblage GFPD-600V doivent être protégés avec conduit ou anneaux

2.0 DIMENSIONS AND FEATURES

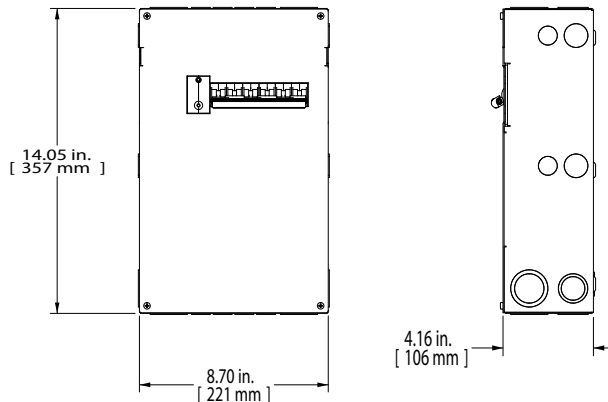

Figure 1. GFPD-600V Box Dimensions

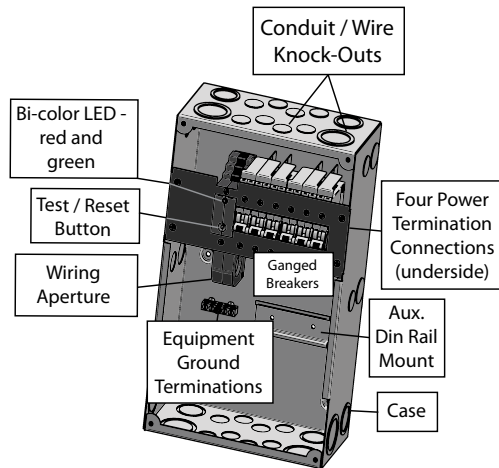

Figure 2. GFPD-600V Box and Major Features

3.0 INSTALLATION

3.1.0 Mounting the GFPD-600V Box

3.1.1 Paired to a Tristar

The GFPD-600V box can be paired with a Morningstar MPPT-600V Tristar charge controller in several ways. A suggested mounting configuration is with the GFPD-600V box to the left of the vertically mounted controller - as shown in Figure 3 - with the two small knock-outs and one large knock-out from each unit lining up.

Two optional mounting configurations are shown in Figures 4 and 5.

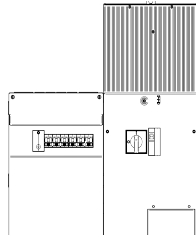

Figure 3. Suggested Mounting

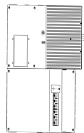

Figure 4. Option 1



Figure 5. Option 2

3.1.2 Coupling

Coupling hardware is provided for joining the two cases using knock-outs as shown below:

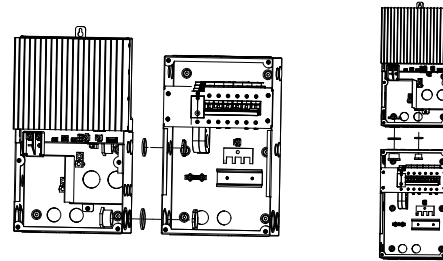
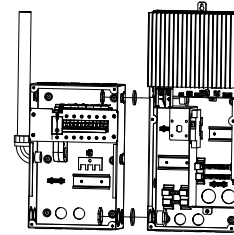

3.1.3 Vertical Mounting

1. If TriStar controller has not been installed, refer to TriStar MPPT-600V operator's manual for mounting instructions, and install.
2. Align GFPD-600V box in desired position and mark the four (4) corner mounting hole locations through the wiring box. Remove the GFPD box.
3. Drill 3/32" (2.5 mm) holes at the drill marks. Align the GFPD box over the holes, and secure the device with four (4) #10 mounting screws.
4. Fasten the mated faces of the two units together at two places using the included coupling hardware as shown above.

3.1.4 Stand-Alone Use

The GFPD-600V can also be coupled with non-Morningstar charge controllers. Wiring will mirror the procedure described in Section 3.2.2, but connecting to another product's terminal lugs instead of a TriStar's. Configuration of the boxes will depend on the application and controller design.

3.2.0 Wiring the GFPD-600V Box



WARNING: Verify that the GFPD-600V breakers and the solar and battery disconnect switches (required) are open before wiring the GFPD-600V box.



AVERTISSEMENT: Vérifiez que les attaquants GFPD-600V et les sectionneurs solaires et batterie (obligatoire) sont ouverts avant de câbler la boîte GFPD-600V.



CAUTION: Wiring methods must conform to the U.S. National Electrical Code or Canadian Electrical Code and ANSI/NFPA 70.



PRUDENCE: Méthodes de câblage doit être conforme au Code électrique National américain ou Canadien Code électrique et ANSI/NFPA 70.

3.2.1 Pre-Wired GFPD-600V / Breaker Assembly

The GFPD-600V and breakers are assembled at the factory. Feedback jumper, shunt and trip signal leads are pre-wired to the GFPD-600V terminals - See Figure 6. The GFPD-600V external voltage source connections are described in the next section - Completing Wiring.

3.2.2 Completing Wiring - See Figures 6, 7 and 8

Step 1. With GFPD-600V / breaker assembly free from box, run solar array (+) (from PV disconnect if installing without DB model controller) and (-) wires through left knock-out and GFPD-600V Wiring Aperture. Remove metal high-low voltage barrier, and run the (+) and (-) breaker<->controller wires into GFPD-600V box through lower mated knock-outs.

Step 2. Crimp the included ring terminals on the ends of the (+) and (-) solar<->breaker conductors, and attach solar array (+) wire to post (2) (load side), and solar array (-) wire to post (4) (line side) using the supplied hardware (see Figure 6).

Step 3. Crimp the included ring terminals on the breaker side ends of the (+) and (-) breaker<->controller wires. Attach breaker side (+) wire to post (3) (line side) and breaker side (-) wire to post (1) (load side) using the supplied hardware (see Figure 6).



NOTE: Use included wire tie to secure wires above breaker assembly as shown in Figures 7 and 8.



REMARQUE: Utilisation fourni attache de fil aux fils sûr ci-dessus assemblée de disjoncteur tel qu'illustré aux Figures 7 et 8.

Step 4. Connect controller side breaker<->controller wires to controller (+) and (-) solar terminal lugs. Replace and secure the metal high-low voltage barrier over the solar wires. Close GFPD-600V breakers.

NOTE: If installing with DB model controller (Figure 8), connect (+) wire to terminal block with yellow wire (goes to PV Disconnect), and connect (-) wire to terminal block with black wire (goes to (-) PV terminal lug). Replace and secure the metal high-low voltage barrier over the solar wires. Close GFPD-600V breakers.

Step 5. Run the supplied (+) and (-) GFPD power terminal wires through a convenient knock-out for connection to voltage source described in Step 9. If installing with a DB model controller, battery terminal blocks can be used for GFPD power connections.

Step 6. Position and fasten GFPD-600V / Breaker assembly into place in the GFPD-600V box.

Step 7. Run (+) and (-) controller<->battery wires into the controller through right upper level knock-out above the metal high-low voltage barrier. If using a Standard Box (Figure 7), connect (+) and (-) controller <->battery wires directly to controller's (+) and (-) battery terminal lugs. If using a DB model controller, see note in Step 8.

Step 8. Wire controller<->battery (+) through external battery disconnect to battery (+) terminal, and connect. Connect controller<->battery (-) wire to battery (-) terminal.

NOTE: If installing with DB model controller (Figure 8), connect (+) controller side controller<->battery wire to (+) terminal block (goes to battery disconnect switch). Connect (-) controller<->battery wire to (-) terminal block (goes to controller (-) battery terminal). Connect (+) battery side controller<->battery wire to (+) battery terminal. Connect (-) wire to (-) battery terminal.

Step 9. Using in-line fuse holder and 5A fuse, install fuse 6 to 12 in. from (+) battery terminal. Connect (+) and (-) wires from GFPD-600V to external 10-72V source (usually system battery) (+) and (-) terminals.

 NOTE: Do not tap from a lower voltage battery bank section that is part of a higher voltage bank - an imbalance will occur.

 WARNING: The PV system must be properly grounded

 AVERTISSEMENT: Le système PV doit être correctement mise à la terre.

Step 10. Ground the PV system properly by electrically connecting each individual metallic component such as PV frames, conduit, combiner boxes, controllers, inverters, GFDIs, and any other dead metal to Earth ground. Locate the system ground on the battery side at either a battery (+) or battery (-) terminal depending on system polarity. Install the grounding system in accordance with local codes and regulations.

Step 11. Close battery disconnect switch.

Step 12. Close solar disconnect switch.

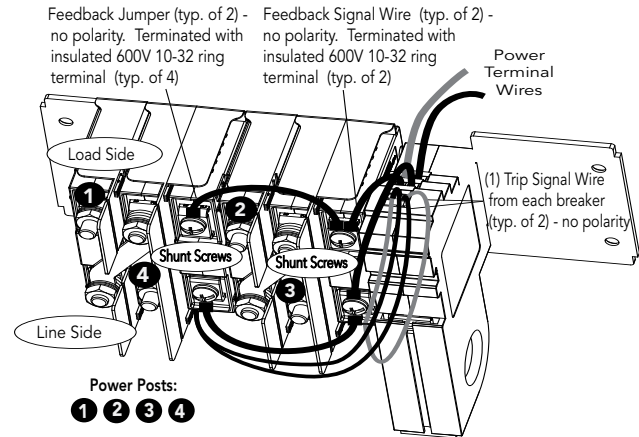

Figure 6. Pre-Wired GFPD-600V / Breaker Assembly

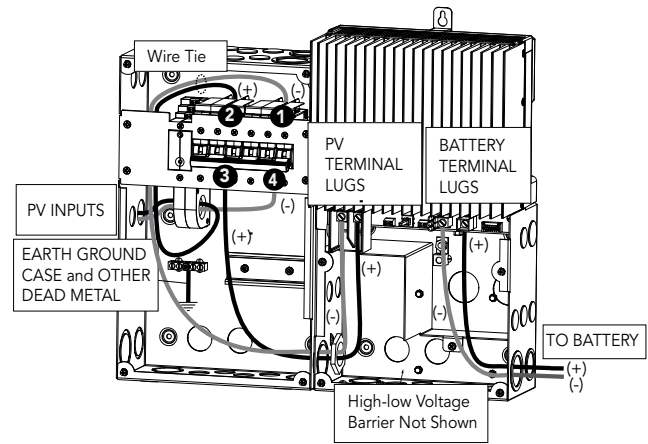

Figure 7. Completing Wiring for Standard Box

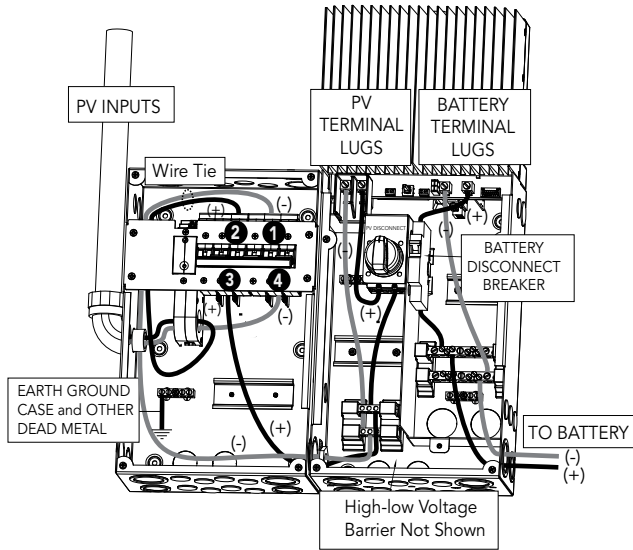

Figure 8. Completing Wiring for DB Model

4.0 GFPD-600V OPERATION

4.1 Ground-Fault Detection

Ground-fault protection is used in electrical systems to prevent current from following any unintended paths. It is critical to detect any stray current, and to interrupt (break) the circuit until safe operation can be restored.

Any current imbalance between the (+) and (-) conductors of a circuit indicates a ground-fault. Morningstar's GFPD-600V will detect this condition, and break the circuit on both the (+) and (-) legs, ensuring interruption.

4.2 LED Indications and Audible Warnings

A bi-color LED and buzzer indicate operating status, a ground-fault event, module/wiring faults and low battery voltage.

GFPD-600V Condition	LED / Buzzer Indication
Start-up	Three green flashes
Normal	Solid green
Ground-fault Detected or Ground-fault Trip	Solid red + buzzer (3 sec. beep / min.)
Ground-fault Error	Red flashing + buzzer
Wiring Error or Open Breaker Alarm	Red / green flashing
Low Battery Voltage Threshold Reached	Buzzer (beep 3x / min.)
Critical Fault	Red / red / green / green

4.3 Test Button Uses

The test button can be used for three purposes:

1. With the GFPD-600V in normal mode, pressing the test button conducts a system test that opens the breaker, shows a red solid LED, and sounds the buzzer.
2. When a ground-fault error has occurred, pressing the test button resets the GFPD-600V to the normal condition.
3. When a wiring error / open breaker alarm has occurred, pressing the test button resets the GFPD-600V to the normal condition.

5.0 TROUBLESHOOTING

5.1 Faults and Corrections

The diagnostic flow diagram in Figure 8 on page 15 illustrates the possible GFPD-600V faults.

- ◆ When a ground-fault error has occurred, push the test button and then close the breaker to resume normal operation. Have a qualified technician investigate the ground-fault cause.
- ◆ When a wiring error / open breaker alarm has occurred, correct wiring error and/or close breaker. Push the test button to resume normal operation.
- ◆ When the minimum requirement of 9 Volts is reached, a buzzer will sound. To resume normal operation, re-charge or replace the voltage source powering the GFPD-600V.
- ◆ Push the test button to perform a system test. Close the breaker to resume normal operation.
- ◆ A critical fault indicates a hardware malfunction. Please contact Morningstar for instructions.
- ◆ If previous trouble-shooting does not correct the problem, re-start the unit by removing in-line source fuse, and re-installing.

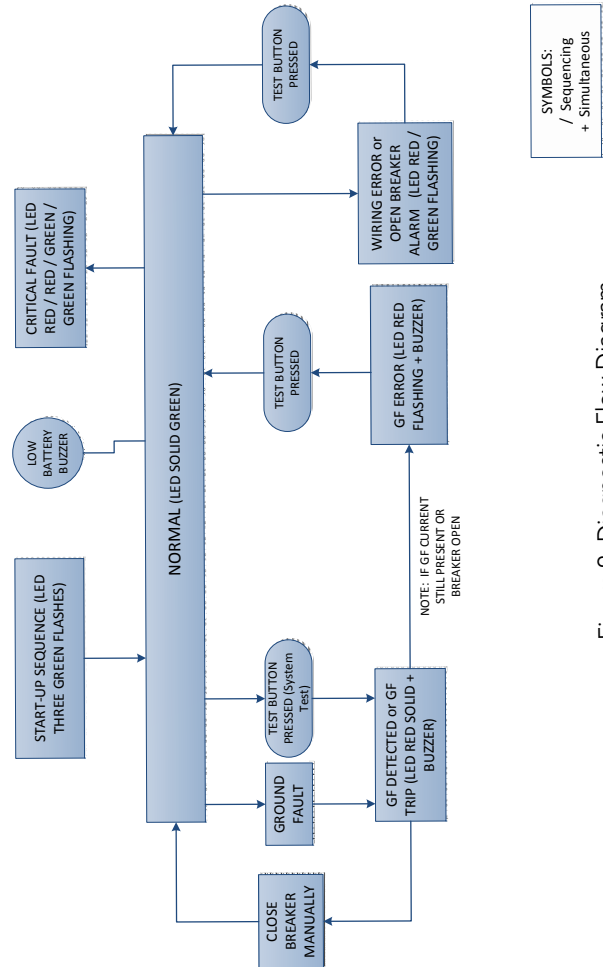

Figure 9. Diagnostic Flow Diagram

6.0 WARRANTY

The GFPD-600V Ground-Fault Protection Device is warranted to be free from defects in material and workmanship for a period of FIVE (5) years from the date of shipment to the original end user. Morningstar will, at its option, repair or replace any such defective products.

CLAIMS PROCEDURE

Before requesting warranty service, check the Operator's Manual to be certain that there is a problem with the controller. Return the defective product to your authorized Morningstar distributor with shipping charges prepaid. Provide proof of date and place of purchase.

To obtain service under this warranty, the returned products must include the model, serial number, detailed reason for the failure, the module type, array size, type of batteries and system loads. This information is critical to a rapid response to your warranty claim.

Morningstar will pay the return shipping charges if the repairs are covered under the warranty.

WARRANTY EXCLUSIONS AND LIMITATIONS

This warranty does not apply under the following conditions:

- Damage by accident, negligence, abuse or improper use.
- PV or load currents exceeding the ratings of the product.
- Unauthorized product modification or attempted repair.
- Damage occurring during shipment.

THE WARRANTY AND REMEDIES SET FORTH ABOVE ARE EXCLUSIVE AND IN LIEU OF ALL OTHERS, EXPRESS OR IMPLIED. MORNINGSTAR SPECIFICALLY DISCLAIMS ANY AND ALL IMPLIED WARRANTIES, INCLUDING, WITHOUT LIMITATION, WARRANTIES OF MERCHANTABILITY AND FITNESS FOR A PARTICULAR PURPOSE. NO MORNINGSTAR DISTRIBUTOR, AGENT OR EMPLOYEE IS AUTHORIZED TO MAKE ANY MODIFICATION OR EXTENSION TO THIS WARRANTY.

MORNINGSTAR IS NOT RESPONSIBLE FOR INCIDENTAL OR CONSEQUENTIAL DAMAGES OF ANY KIND, INCLUDING BUT NOT LIMITED TO LOST PROFITS, DOWN-TIME, LOSS OF GOODWILL, OR DAMAGE TO EQUIPMENT OR PROPERTY.

7.0 TECHNICAL SPECIFICATIONS

ELECTRICAL:

- ◆ **Maximum Solar Voltage**.....600 vdc
- ◆ **Maximum Solar Current** 50 adc
- ◆ **GFPD-600V Supply Voltage Range**..... 10-72 vdc
- ◆ **Ground-Fault Current Trip Threshold**.....300mA +/- 10%
- ◆ **Self-consumption**<1W
- ◆ **Transient Surge Protection**3000W Battery and 1500W Signal Port

ELECTRONIC PROTECTIONS:

- ◆ **Reverse Polarity**
- ◆ **Disconnected Feedback Signal Circuit Detection**

MECHANICAL:

- ◆ **Dimensions (in/cm)**..... 14.1 x 8.7 x 4.2 / 35.7 x 22.1 x 10.6
- ◆ **Enclosure**.....Type 1 Indoors
- ◆ **Weight**..... 8.9 lbs / 4.04 kgs
- ◆ **Aperture Diameter**.....0.79 in. (20.0 mm)
- ◆ **Breaker Power Posts**.....1/4 in. - 20 Studs
- ◆ **Recommended Breaker Power Post Nut Torque**.....30-35 in-lb (3.4-4 Nm)
- ◆ **Recommended GFPD-600V Sensing Unit Terminal Torque**.....3.5 in-lb (0.4 Nm)
- ◆ **GFPD-600V Sensing Unit - Minimum Conductor Temperature Rating**...75°C
- ◆ **Battery Wire**.....33 ft. two-conductor 18 AWG - stranded copper or aluminum
- ◆ **Battery Fuse Holder**.....In-line
- ◆ **Battery Fuse**.....5A, min. 125 vdc
- ◆ **Trip Signal Wire Harness**.....8.5 / 10.5 in. two-conductor 18 AWG stranded copper
- ◆ **Feedback Jumpers**.....(2)-4.5 in. 600V single-conductor stranded copper or aluminum
- ◆ **Feedback Signal Wire Harness**.....3.5 / 6.5 in. 600V two-conductor 14 AWG stranded copper or aluminum
- ◆ **Mounting (GFPD-600V Module)**...35 mm DIN Rail or Panel Mount with (2)-#6-32 screws

7.0 TECHNICAL SPECIFICATIONS (Cont.)

ENVIRONMENTAL:

- ◆ **Operating Temperature Range**.....-40°C to +60°C
- ◆ **Storage Temperature Range** -55°C to +85°C
- ◆ **Humidity Tolerance**.....Up to 100%
- ◆ **Tropicalization**..... PCB Conformal Coating

8.0 CERTIFICATIONS

- ◆ Meets U.S. NEC requirements for use as a GFDI / GFPD
- ◆ ETL Listed to UL 1741 and CSA C22.2 No. 107.1-01
- ◆ EMC Directives Immunity, Emissions, Safety
- ◆ FCC Class B Part 15
- ◆ CE
- ◆ RoHS
- ◆ ISO 9000